

VOILÀ Q60 H110

designed by Area Declic Design



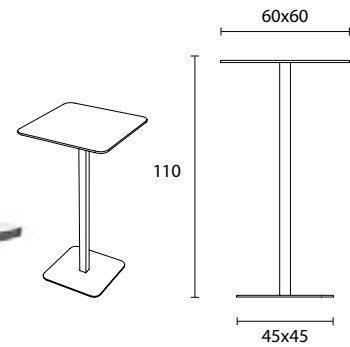

Perfetto per tutte le esigenze. Tavolo a colonna, con basamento di acciaio. Il piano è in laminato stratificato HPL (metodo ad alta pressione) o ALU (con anime di alluminio "annegate" prima della policondensazione). Disponibile in vari colori e abbinamenti di finiture.

Perfect for every requirement. Table with column and steel base. The top is in stratified laminate HPL (by high pressure method) or ALU (with aluminium sheets inserted between its construction layers before poly-condensation). Available in various colours and finishes.



Art. 632

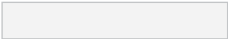

HPL HPL

	Alluminio P93	Aluminium P93
	Antracite P106	Anthracite P106
	Rovere moka P104	Oak moka P104
	Bianco P107	White P107
	Nero P118	Black P118

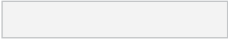
ALU ALU

	Bianco P84	White P84
	Antracite P85	Anthracite P85
	Alluminio P86	Aluminium P86

Peso collo: 23,5 kg  
Volume: 0,06 m<sup>3</sup>  
Peso netto: 21,5 kg  
Pezzi per scatola: 1  
Colli: 3

Disassemblato

**Finiture e colori:**

piano in laminato stratificato HPL bianco P107, nero P118, antracite P106, alluminio P93, rovere moka P104 o ALU bianco P84, antracite P85, alluminio P86.

**Struttura:**

basamento in inox satinato e montante centrale in acciaio cromato S1; basamento e montante centrale in acciaio verniciato bianco S26, nero S24 o alluminio S14.

Box weight: 23,5 kg  
Volume: 0,06 m<sup>3</sup>  
Net weight: 21,5 kg  
Pcs per box: 1  
Boxes: 3

Disassembled

**Finishes and colours:**

top in laminated layered HPL white P107, black P118, anthracite P106, aluminium P93, oak moka P104 or ALU white P84, anthracite P85, aluminium P86.

**Frame:**

square base in satinated stainless steel finishing and central leg in steel chromed S1; base and central leg in steel painted black S24, white S26 or aluminium S14.